

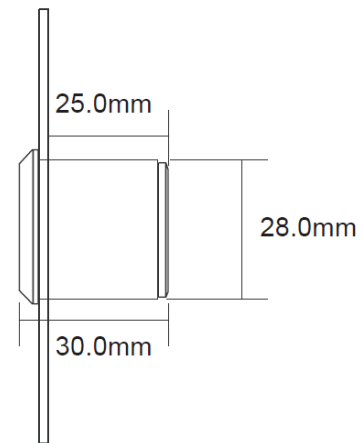

Model : **ON-SNT850** Touchless Sensor Exit Button

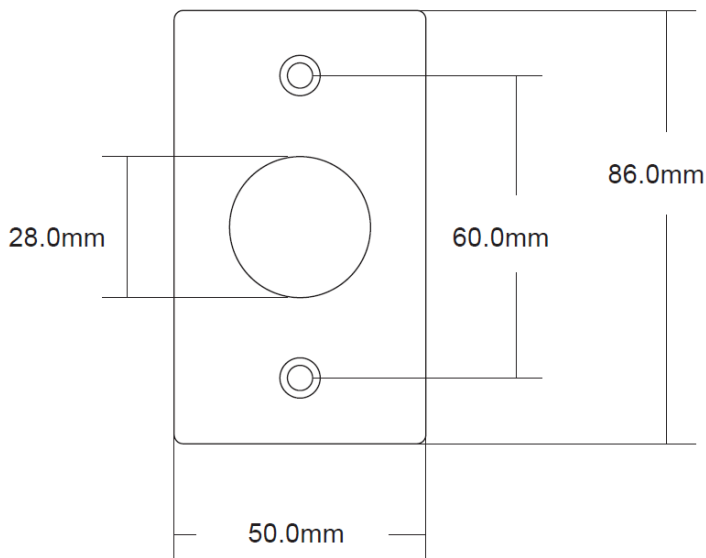

Features :

- **Dimensions:** 86L*50W*25H(mm)
- **Contact Rating:** 12-24V, 3A
- **Power:** 12VDC & 24VDC
- **Output Contact:** NO/NC/COM
- **Mechanical Life:** 500,000 Tested
- **Suitable for Door:** Hollow Door
- **Logo:** Customizable
- **Weight:** 0.1kg
- **Operating Temp:** -20 °C ~ +55 °C (14-131F)
- **Operating Humidity:** 0-95%(relative humidity)
- **LED Indicator:** Blue LED Indicator (Standby)
Green LED Indicator (Sensation)
- **Surface Mount:** Optional M50 or PG50 Back Box
- **Panel:** 1.7mm Thick 304 Stainless steel
- **Package Quantity:** 100pcs/11kg/51*45*24cm/ctn