

### A. Package Content

Controller x 1, wall hanger x 1, user manual x 1, screwdriver x 1, kit pack x 1

Kit pack : screw x 4, screw anchors x 4, diode (1N4004) x 1, 4 pin cable x 1, 8 pin cable x 1, 9 pin cable x 1

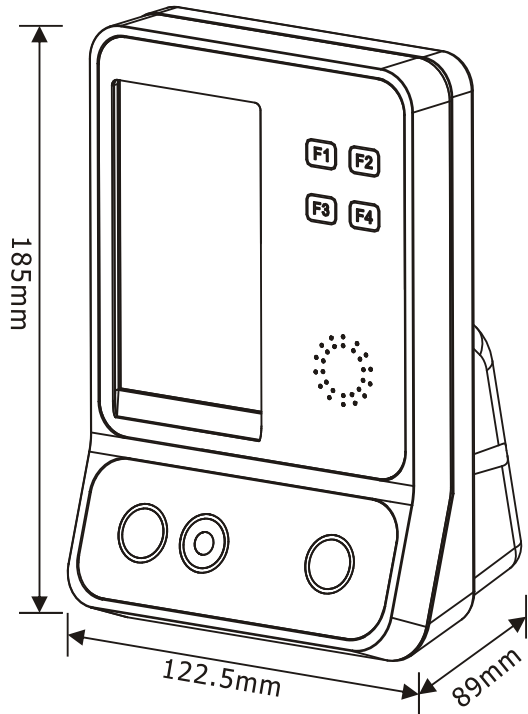

### B. Wall-Hanger Dimension

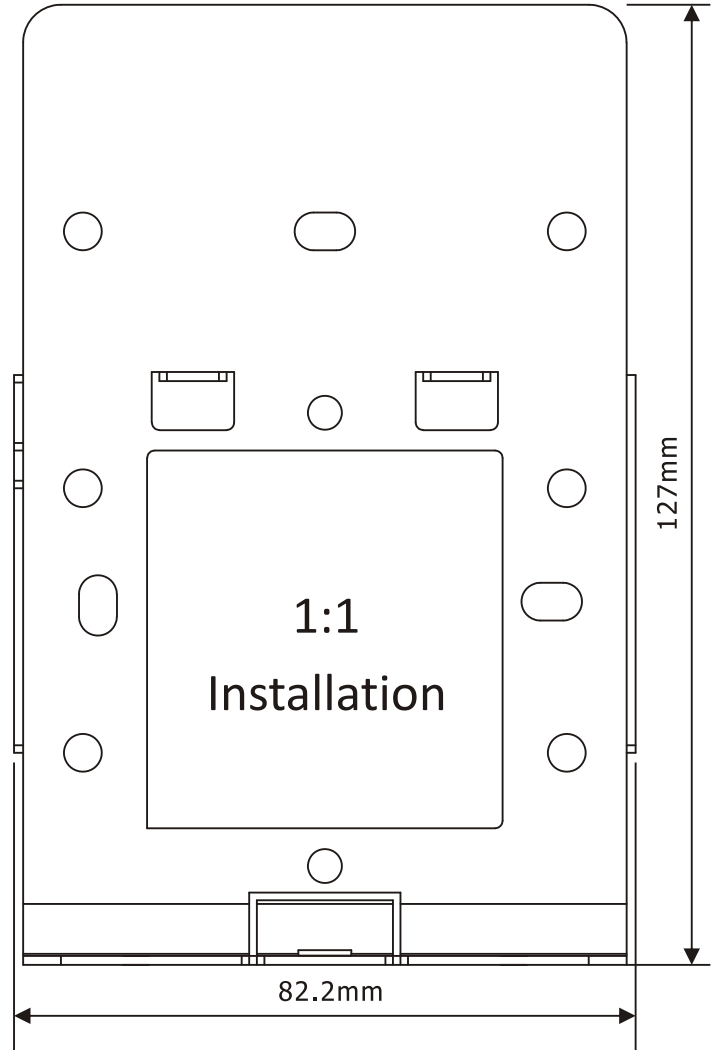

### C. Specification

- Dimension : 122.5 x 185 x 89(mm)
- Power : 9~24 VDC/ 1A
- Wiegand communication : Max to 100 meters
- RS485 communication : Max to 1000 meters
- Face recognition distance : 30 ~ 80 cm
- Recommend installation height 120 ~ 130 cm

### D. Installation Instructions

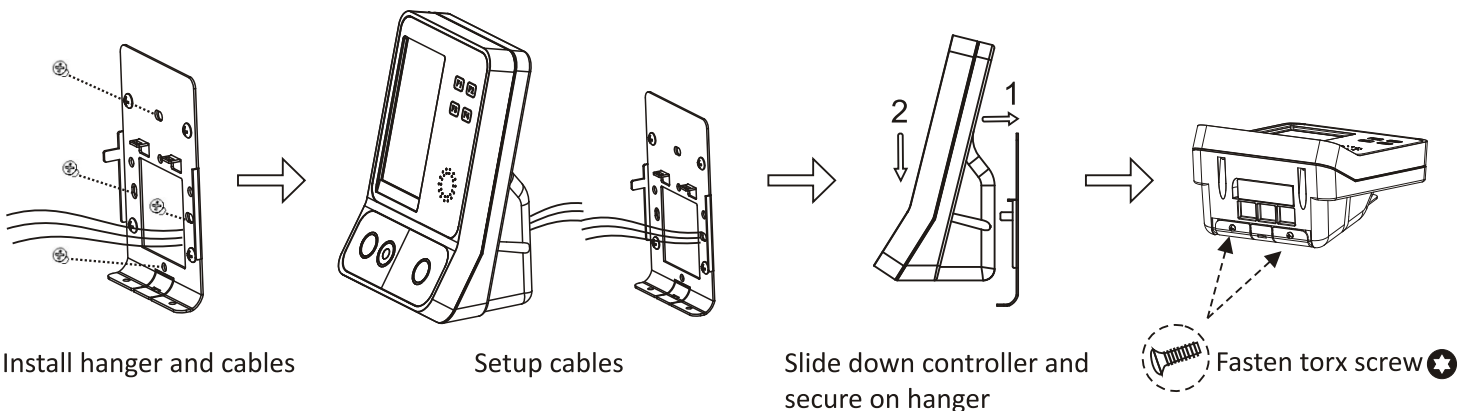

## E. Application Structure

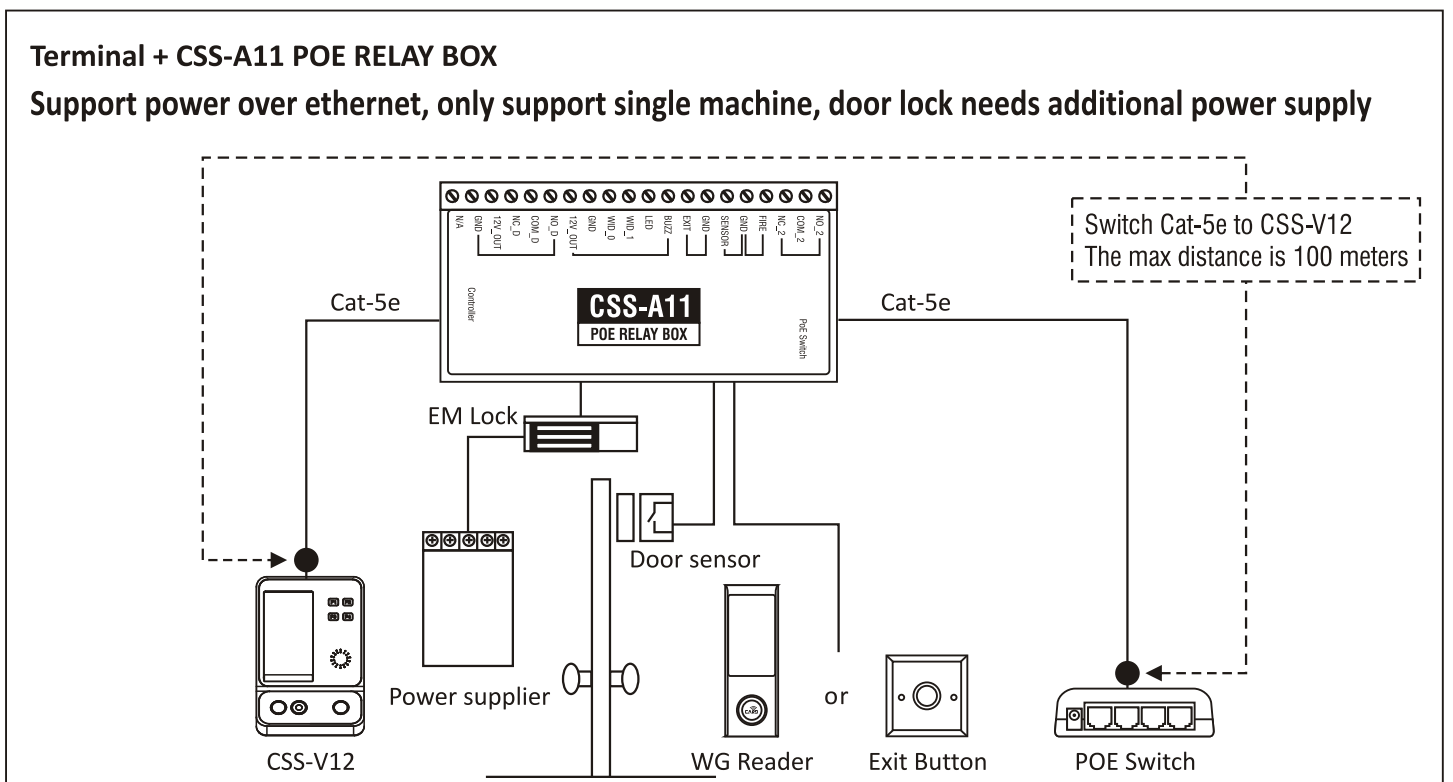
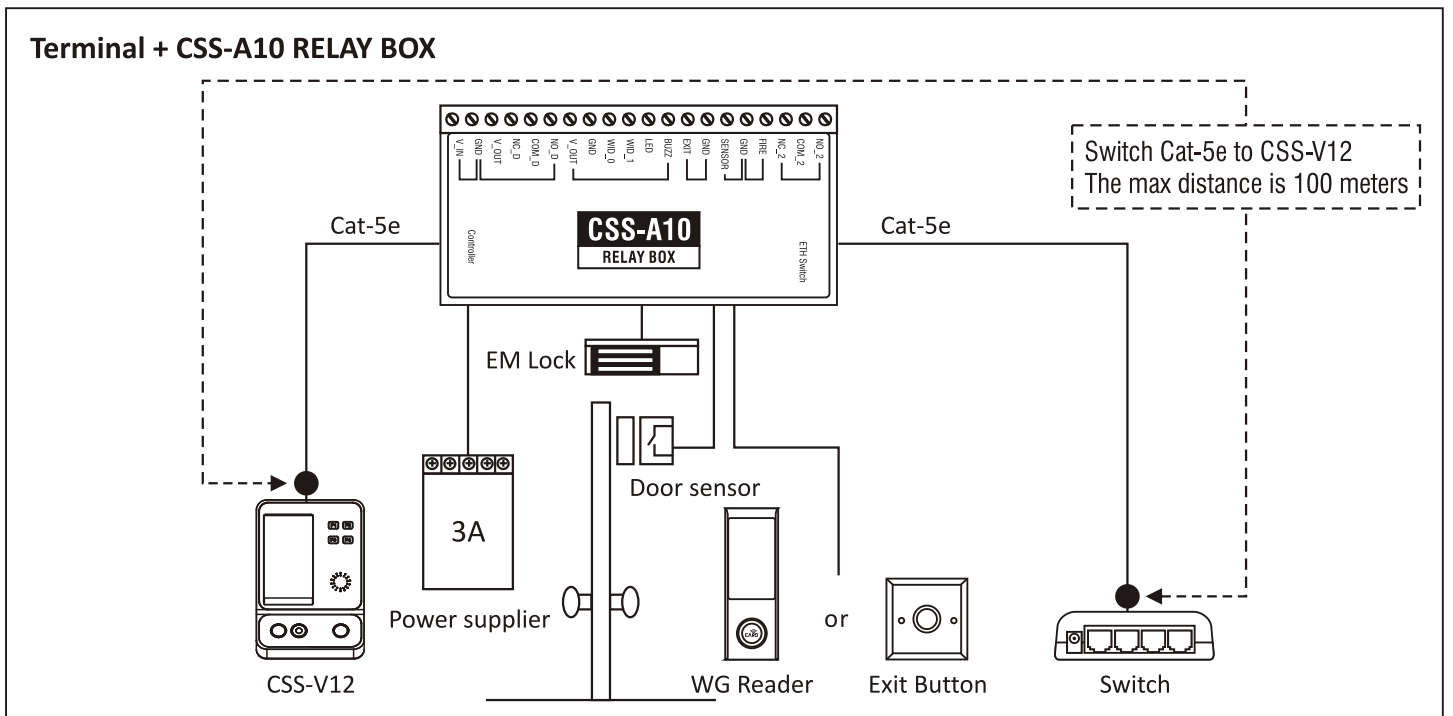
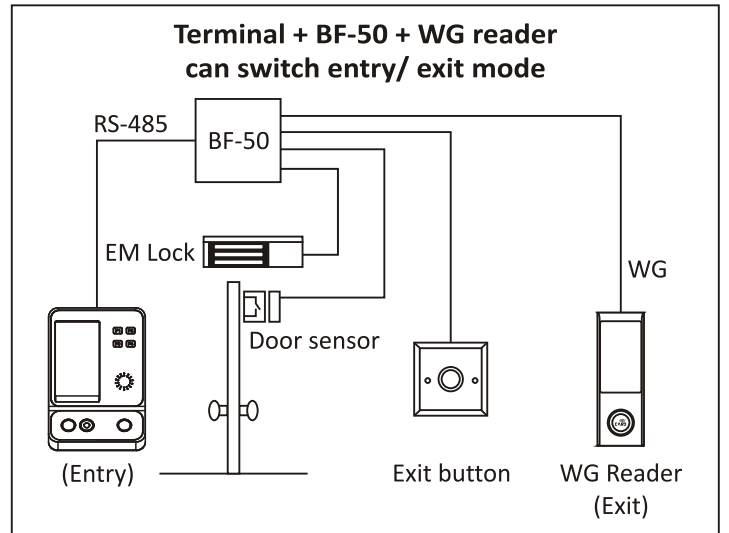
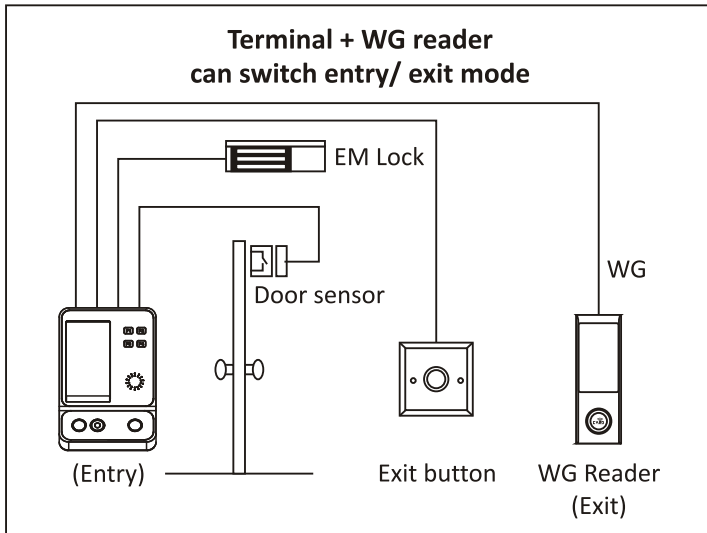

## F. Terminal Frontside Description

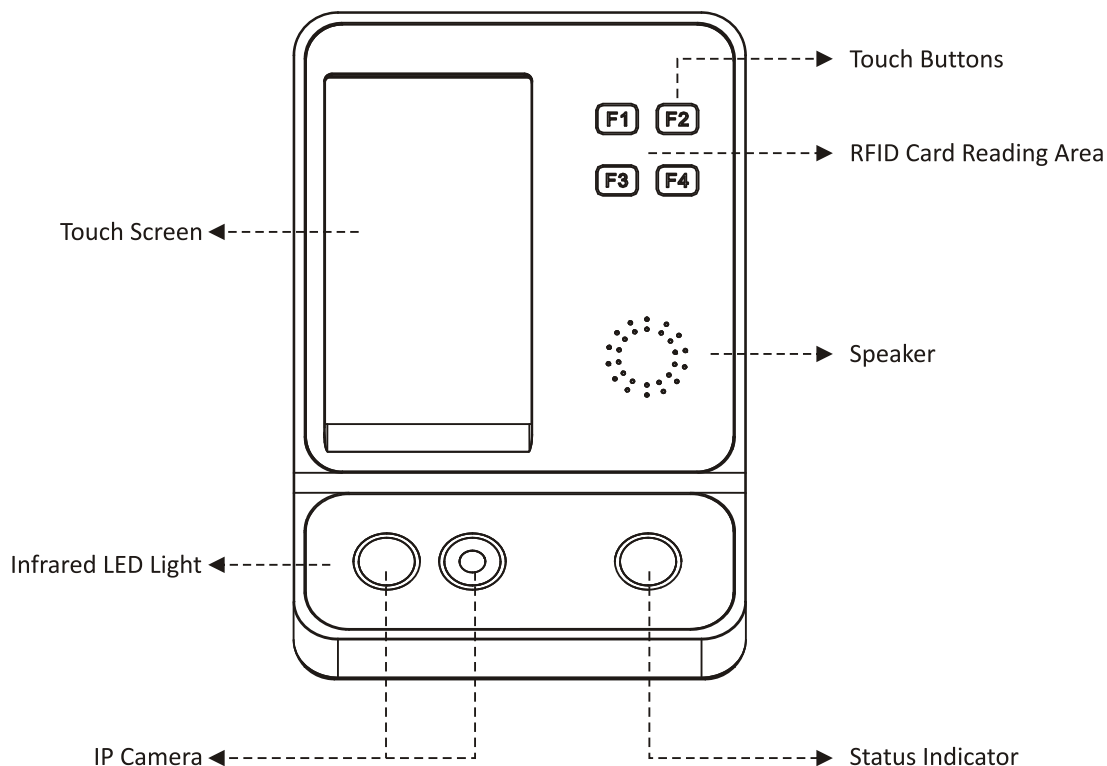

## G. Installation

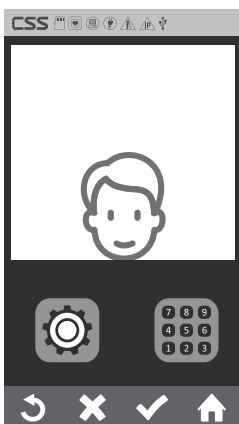

Recommend installation height	
Ground to bottom of the device (CM)	Users Height (CM)
120	153~185
122	155~190
124	157~195
126	159~200
128	161~205
130	163~210

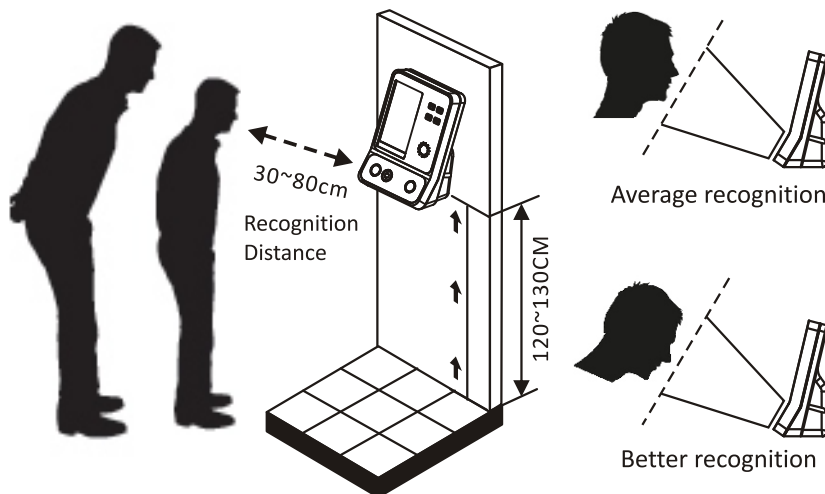

Recognition distance is 30~80 (cm)

For shorter person minimum requirement is have chin align to the lower edge of the display frame

Please refer to above chart for best installation of device vs user

Please bow your head slightly to have better recognition rate

## H. installation Environment

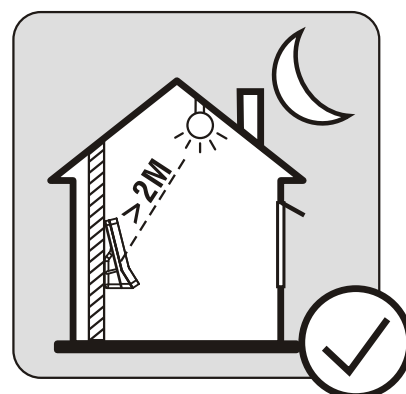
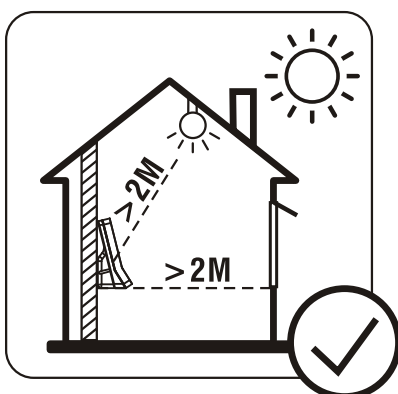
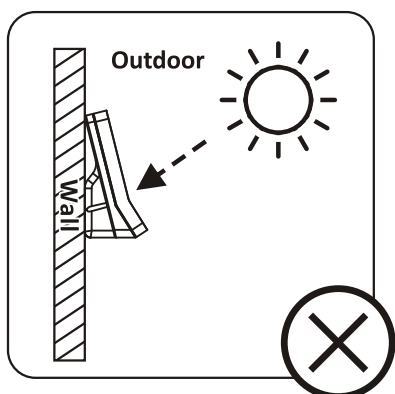

Please avoid directly sunshine and keep at least 2 meters away from lights

## I. Terminal Backside Explanation

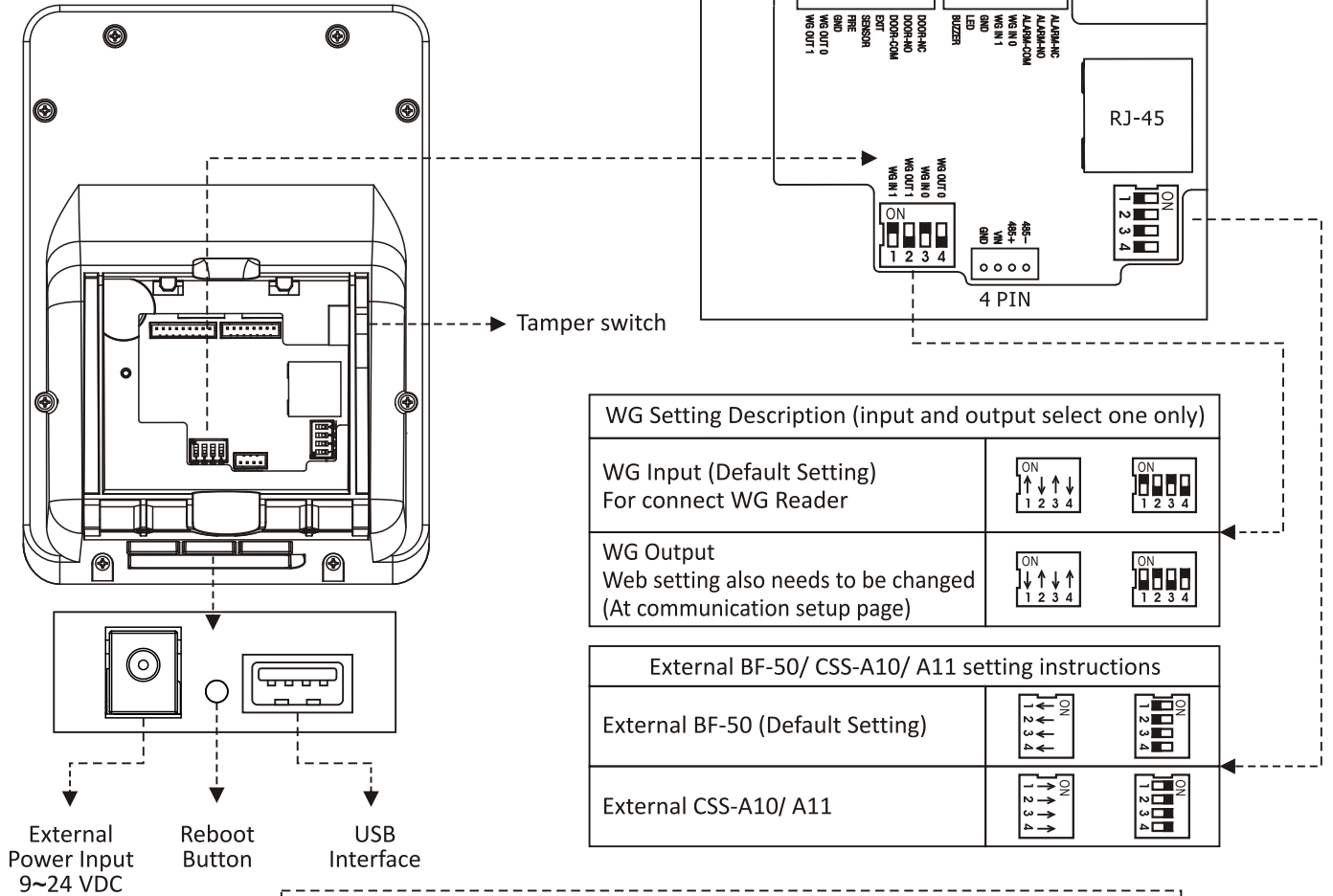

## J. Cable Diagram

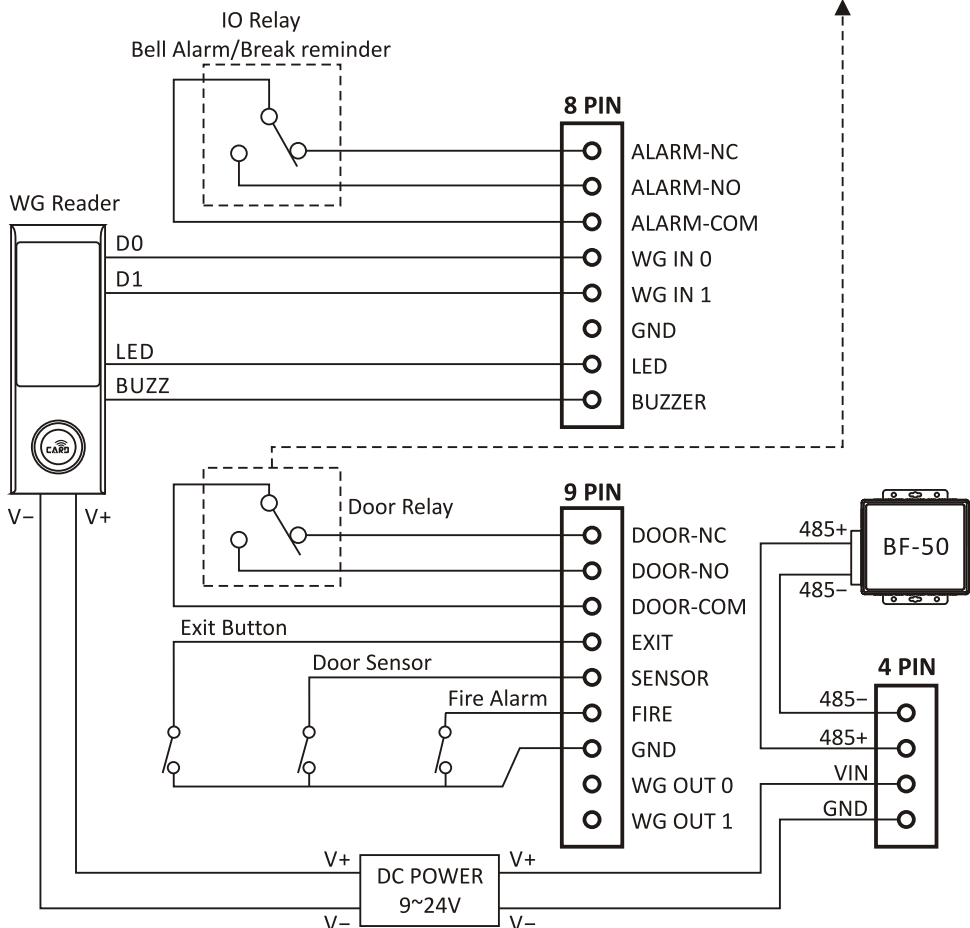

## K. Cable Description

4 PIN		
485-	GRAY	For Relay Box BF-50
485+	BROWN	
VIN	RED	DC 9~24V (1A)
GND	BLACK	

8 PIN		
ALARM-NC	YELLOW BLACK	IO Relay Bell Alarm/ Break Reminder
ALARM-NO	WHITE BLACK	
ALARM-COM	GREEN BLACK	
WG IN 0	RED WHITE	WG Input Connect WG Reader
WG IN 1	BLACK WHITE	
GND	BLACK	GND
LED	ORANGE	Control WG Reader LED/ Buzzer Action
BUZZER	PINK BLACK	

9 PIN		
DOOR-NC	YELLOW	Door Relay
DOOR-NO	WHITE	
DOOR-COM	GREEN	
EXIT	VIOLET	Exit Button
SENSOR	BLUE	Door Sensor
FIRE	PINK	Fire Alarm
GND	BLACK	GND
WG OUT 0	GRAY BLUE	WG Output
WG OUT 1	ORANGE BLACK	