

- (12) Set the LCD screen backlight status (on or off)

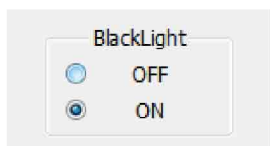

- (13) Set the external signal output mode, there are two modes (switch mode and pulse mode)

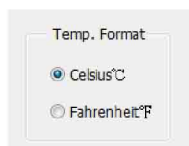

- (14) Display the current date, time and current environment temperature

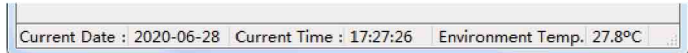

5.FAQ

1. Q:Can't open the serial port and show COM1?

- A: ①Wrong selection of COM port. Solution: Connect the USB cable before opening the software, so that it will automatically recognize the port number
 ②The USB driver is not updated. Solution: Connect to the network, right-click on my computer, open the resource manager, and update the driver.
 ③ Is the USB cable or computer port normal? Change the USB cable or port and test again.

2. Q:The data is not refreshed after the serial port is opened?

- A: Check if the USB cable is normal, change to another USB cable to test it.

Software User Guide

This software only supports windows system

1. Turn on the top switch of the thermometer, use the data cable to connect with the USB interface of the computer, and install the USB serial port driver.

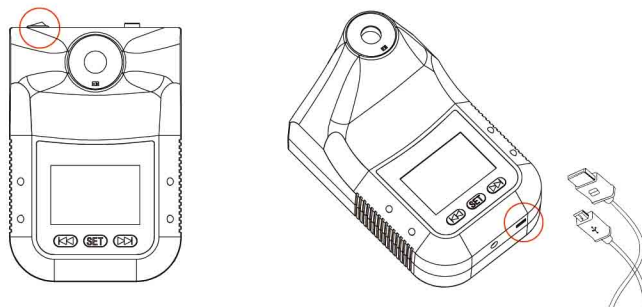

Note: The driver is usually installed automatically. If you encounter an installation failure, you need to manually install the USB driver. The software package contains part of the program dependent files. Changes will cause errors in the program. Please check the following instructions carefully.

2. Operation process

Download path abroad <https://bit.ly/2zpHixa>

- (1) Open the installation package folder and double-click the Setup.exe icon



- (2) When the software is opened for the first time, a prompt dialog box of "Control Registration Successful" will pop up normally, click the "OK" button



1.Click "Next"

2. Install to the default folder, Click "Next"

3) Click 'Next' until the installation is complete

- (3) Open the default installation path (default installation path: D drive \\ TestACY folder)



- (4) Double-click the software start up icon "TestACY"



- (5) The main page of the software automatically pops up. After confirming that the thermometer is turned on and successfully installing the driver, click "Connect"

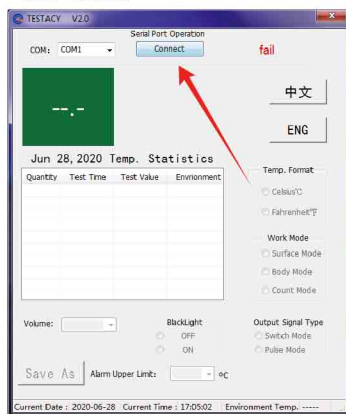

- (6) "Fail" will change to "success"

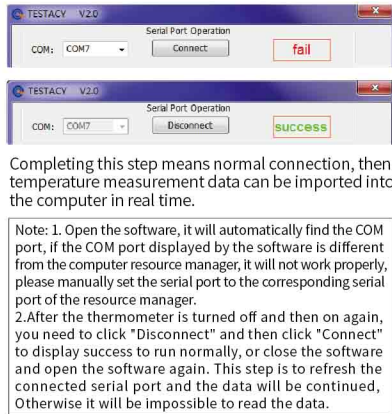

3.Data viewing and export

1. [Text Data View] The "Quantity, Time, Measured Temperature, Environmental Temperature" data that will be generated after using the thermometer, the folder "TempData \\ year \\ month \\\" will be automatically generated in the software package by Year Month Day sequence recording, the format is "TXT" text.

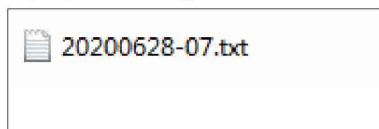
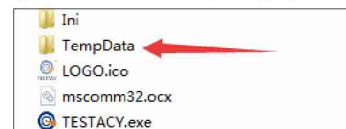

2. [Excel Data View] Click "Save As" on the software panel and select "CSV format" to export the Excel file format

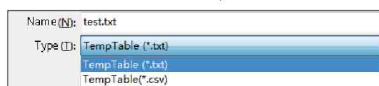
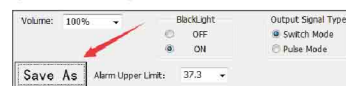

4. Software Introduction

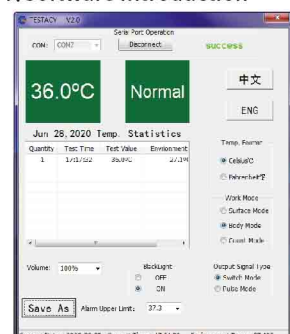

- (1) Software name: TESTACY



This part is mainly to establish a communication relationship with the infrared thermometer, so that the software can normally receive the temperature data measured by the infrared thermometer. If the communication is normal: display success, otherwise fail.

- (2) Display the temperature that currently received. When the software just opened and not received the data sent by the infrared thermometer, "--,--" will be displayed.

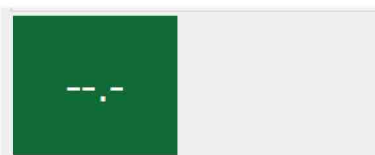

- (3) When the measured temperature is displayed, "normal" is displayed under normal conditions. If it exceeds a certain upper limit value, "abnormal" will be displayed.



- (4) Display Chinese interface,broadcast Voice in Chinese



- (5) Display English interface,broadcast Voice in English



- (6) Record the measured temperature data of the day, including the measured quantity, the test time and the measured temperature corresponding to each measurement object. The environment temperature at the time of measurement.

Jun 28, 2020 Temp. Statistics				
Quantity	Test Time	Test Value	Environment	
2	17:21:54	36.6°C	27.1	
3	17:21:59	36.3°C	27.1	
4	17:22:01	36.4°C	27.1	
5	17:22:17	36.0°C	27.1	
6	17:22:29	36.5°C	27.1	
7	17:22:30	36.3°C	27.1	
8	17:22:31	36.4°C	27.1	
9	17:22:32	36.4°C	27.1	

- (7) The user can choose the temperature display format as needed.

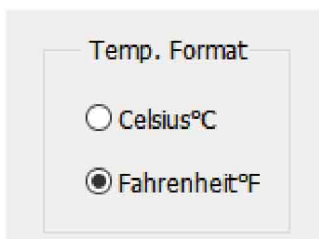

- (8) The user can choose the temperature test mode as needed.

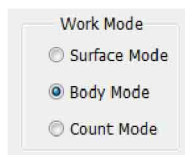

- (9) The default data is saved in the current path, the user can use this button to save the data of the day, you can re-select the path and set the file name, the suffix can choose .txt or .csv. Users who choose .csv can check it with Excel



- (10) Set the Alarm temperature

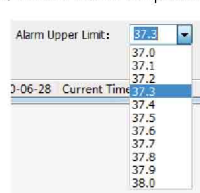

- (11) Set the sound volume of the thermometer speaker, there are 5 levels (0, 25%, 50%, 75%, 100%)

